

# Containment ring problem

## A comparative case study using the Contradiction Table, Ideation Improver<sup>ā</sup>, and the Innovation WorkBench<sup>ā</sup> System software<sup>1</sup>

Boris Zlotin, Alla Zusman and Len Kaplan

Edited by Vicki Roza

March 2000

Ideation International, Detroit, MI

© 2000 Ideation International Inc.

## Introduction

The variety of TRIZ tools available provides considerable flexibility in learning and utilizing TRIZ, but also creates confusion in the minds of new and potential TRIZ users. What are the differences between the various tools? Which tool (or tools) should be learned first? To which type of problem should each tool be applied?

Indeed, each tool has its own advantages and limitations, and in an effort to provide clear and credible answers to these questions, the study described herein was undertaken<sup>2</sup>.

As we have mentioned in previous publications<sup>3</sup>, TRIZ tools can be divided into two groups:

*Analytical tools* that help to define, formulate and model a problem, and include:

- ARIZ
- Substance-Field Analysis
- Innovation Situation Questionnaire<sup>TM</sup> (ISQ)<sup>4</sup>
- Problem Formulator<sup>TM</sup>

*Knowledge-base tools*, derived from the accumulated knowledge of the human innovative experience, and organized and structured to provide users with the highest degree of problem-solving value. These include:

- Patterns/Lines of Technological Evolution
- 40 Innovation Principles (in conjunction with the Contradiction Table)
- Separation Principles

---

<sup>1</sup> The portion of the case study conducted using the Innovation WorkBench (IWB) System will be published in the next issue.

<sup>2</sup> See also "Comparative Analysis of Selected TRIZ Tools," *TRIZ in Progress* (Ideation International, 1999).

<sup>3</sup> "Tools Overview and Structure," Ideation/TRIZ Methodology course material (Ideation International, 1995).

<sup>4</sup> The ISQ and Problem Formulator are recently-developed Ideation TRIZ analytical tools.

- 76 Standard Solutions
- Innovation Guide (“Effects”)
- Selected Innovation Examples
- System of Operators<sup>5</sup>

To demonstrate how the various tools can be used and what kind of results can be achieved, we applied each tool to the same “real life” problem. We selected a problem concerning a Containment Ring, for the following reasons:

- This problem was submitted to us by our first American customer to test the capabilities of TRIZ
- It had been translated into Russian and sent to several dozen TRIZ specialists in Russia, Israel and the United States
- Over 100 solution ideas were obtained from various TRIZ specialists<sup>6</sup>
- Over 80% of the solution ideas were fairly consistent
- A patent application involving one of the solution ideas was filed.

---

<sup>5</sup> A recent Ideation TRIZ tool that incorporates the 40 Innovation Principles, Separation Principles, 76 Standard Solutions, selected Patterns/Lines of Technological Evolution, and more into an integrated, net-like structure. See details in Boris Zlotin and Alla Zusman, “An Integrated Operational Knowledge Base,” *TRIZ in Progress* (Ideation International, 1999). Also posted on the Ideation International web site ([www.ideationtriz.com](http://www.ideationtriz.com))

<sup>6</sup> The relatively high number of solutions was the result of limited initial information about the problem and system, especially with regard to constraints on system changes. We therefore aimed at an exhaustive set of potential ideas, which could later be screened.

## Problem description

An armor-steel “containment ring” is designed to contain the fragments from an impeller burst of a maximum speed fan. The system consists of the fan, a fan shroud (which controls the direction of the air stream), and the containment ring (see Figure 1). The problem is this: the containment ring is too heavy, and must be reduced in weight by 50%.

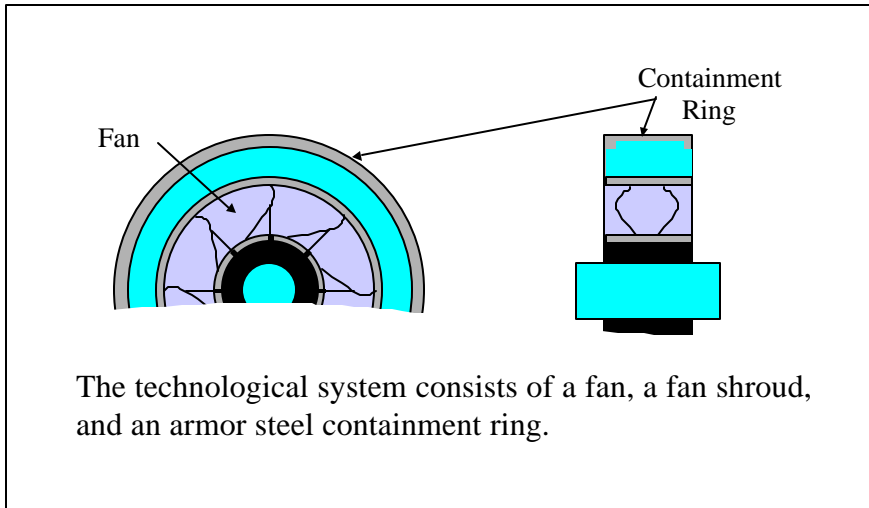

## Selection of tools

The “map” shown below was used to select the appropriate tools, depending on the type of problem statement (in terms of parameter, functions, contradictions, etc.).

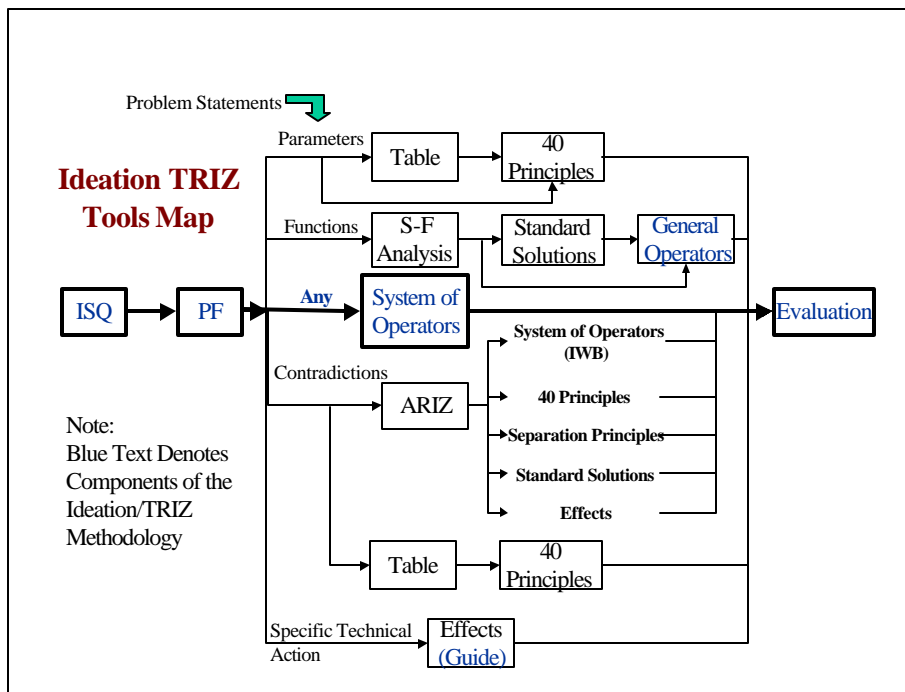

As the problem is stated in terms of a particular *parameter* (weight reduction) and contains a hidden technical contradiction<sup>7</sup>, the following tools were selected:

- Contradiction Table and 40 Innovation Principles
- System of Operators

The following tools were excluded from consideration:

- Su-Field Analysis<sup>8</sup>
- 76 Standard Solutions
- ARIZ<sup>9</sup>
- Separation Principles<sup>10</sup>

As mentioned earlier, the System of Operators is a complex, net-like tool containing numerous internal links – thus, it can be fully utilized only in a software environment. We selected the following Ideation software tools, both of which incorporate the System of Operators:

The *Ideation Improver*<sup>11</sup> *System* contains an abbreviated version of the System of Operators. The Improver is designed to be used to improve typical technical parameters of a product/process. Weight is one such parameter, making the Improver a suitable tool for the containment ring problem.

The *Innovation WorkBench*<sup>12</sup> is a professional problem-solving software product that incorporates a comprehensive set of tools, including:

- Innovation Situation Questionnaire (ISQ)
- Problem Formulator
- System of Operators
- Innovation Guide
- Selected Innovation Examples

### **Main principle underlying the development of a TRIZ case study**

It is widely known among TRIZ professionals that success in problem solving is dependent on the following components:

- TRIZ Methodology/Philosophy (M)

---

<sup>7</sup> Obviously, the “conventional” method of reducing the weight of the ring by reducing the amount of material used would sacrifice the ring’s mechanical strength.

<sup>8</sup> This tool (as well as the 76 Standard Solutions) is suitable for problems stated in terms of functions – e.g., a system contains a harmful function, an insufficient useful function, or a useful function is absent. The presented problem, however, does not include a functional description of the situation.

<sup>9</sup> The application of ARIZ to this problem will be considered in a separate paper.

<sup>10</sup> There is no apparent Physical Contradiction in the problem statement.

<sup>11</sup> See the Improver main features on [www.ideationtriz.com](http://www.ideationtriz.com)

<sup>12</sup> See information about the IWB on [www.ideationtriz.com](http://www.ideationtriz.com)

- TRIZ tools (T)
- Professional knowledge( $P_{KN}$ ) and expertise in the area the problem is related to
- Personal capabilities ( $P_C$ ) of the problem-solver, including motivation, level of natural creativity, computer literacy, persistence, etc.

The above components can be combined into the following equation:

$$S = P_C \times P_{KN} \times (1+M) \times (1+T)$$

Where S is Success.

In our experience teaching TRIZ, we have witnessed various combinations of the above components – where, for example, natural creativity or persistence can compensate for the lack of TRIZ knowledge, or vice versa. This fact has been demonstrated by a phenomenon well-known in the TRIZ community, where an experienced TRIZ professional finds a solution to a problem within the first steps of ARIZ, while students or less experienced professionals must complete nearly all of the steps before arriving at a solution.

Obviously, in a teaching environment – as well as for the purposes of this comparison – we want to exclude the influence of  $P_C$  and  $P_{KN}$  and focus instead on the methodology. For this reason we have established and complied with the following main principle in the development of educational case studies and in teaching TRIZ students:

***Direct and minimal result:*** The result of each step offered by the methodology and its tools should be directly and clearly derived from the step recommendation or other TRIZ statement/information. In other words, an idea should be obviously prompted by a formulated problem statement, an Operator, Guide recommendation, or Illustration – and not the result of a remote association or from the engineering elaboration of an experienced TRIZ professional.

Excluding the influence of  $P_C$  and  $P_{KN}$  is no easy task, nonetheless, we have tried to do just that in the containment ring case study.

## **Working with the Contradiction Table and 40 Innovation Principles**

Selected feature to improve: *Weight of moving object*

Degraded attribute: *Strength*

The following Innovation Principles are recommended for trying to eliminate the above Technical Contradiction.

- 28. Replacement of a mechanical system
- 27. Inexpensive, short-lived object for expensive, durable one
- 18. Mechanical vibration
- 40. Composite materials

In addition, the following pairs of parameters can be considered:

Selected feature to improve: *Weight of moving object*

Degraded attribute: *Reliability*

Principles recommended:

- 3. Local conditions
- 11. Cushion in advance
- 1. Segmentation
- 27. Inexpensive, short-lived object for expensive, durable one

Selected feature to improve: *Weight of moving object*

Degraded attribute: *Harmful factors acting on object*

Principles recommended:

- 22. Convert harm into benefit
- 21. Rushing through
- 18. Mechanical vibration
- 27. Disposable object (substitute an inexpensive, short-lived object for an expensive, durable one)

Altogether we have obtained nine principles. Each has been considered in turn, yielding the following results:

### **28. Replacement of a mechanical system**

- a. *Replace a mechanical system by an optical, acoustical or olfactory (odor) system*
- b. *Use an electrical, magnetic or electromagnetic field for interaction with the object*
- c. *Replace fields, for instance:*
  - 1. *Stationary fields with moving fields*
  - 2. *Fixed fields with those which change in time*
  - 3. *Random fields with structured fields*
- d. *Use a field in conjunction with ferromagnetic particles*

Idea #1: Apply a magnetic field to contain the fragments.

### **27. Substitute an inexpensive, short-lived object for an expensive, durable one (Disposable object)**

*Replace an expensive object by a collection of inexpensive ones, forgoing certain properties (e.g., longevity).*

Idea #2: Use a disposable ring that will be destroyed while absorbing the energy of the fragments.

### **18. Mechanical vibration**

- a. *Set an object into oscillation*
- b. *If oscillation exists, increase its frequency, even to ultrasonic*
- c. *Use the resonant frequency*
- d. *Instead of mechanical vibration, use piezo-vibrators*
- e. *Use ultrasonic vibration in conjunction with an electromagnetic field*

No ideas.

### **40. Composite materials**

*Replace a homogeneous material with a composite one*

*Example: Military aircraft wings are made of composites of plastics and carbon fibers for high strength and low weight.*

Idea #3: Make the ring from a composite material.

### **3. Local conditions**

- a. *Transition from a homogeneous structure of an object or outside environment/action to a heterogeneous structure*
- b. *Have different parts of the object carry out different functions*
- c. *Place each part of the object under conditions most favorable for its operation*

*Example: To combat dust in coal mines, a fine, cone-shaped mist of water is applied to the working parts of the drilling and loading machinery. The smaller the droplets, the greater the effect in combating dust – the fine mist hinders the work, however. The solution is to develop a layer of coarse mist around the cone of fine mist.*

Idea #4: Use a ring that has a heterogeneous structure.

### **11. Cushion in advance**

*Compensate for the relatively low reliability of an object by countermeasures taken in advance.*

*Example: Merchandise is magnetized to deter shoplifting.*

Idea #5: Consider using additional protection from flying fragments should the reliability of the ring be insufficient.

## **1. Segmentation**

- a. *Divide an object into independent parts*
- b. *Make an object sectional*
- c. *Increase the degree of an object's segmentation*

*Example: Sectional furniture, modular computer components, folding wooden ruler*

Idea #6: Use a multi-layer ring containing additional strengthening rings of different hardness and elasticity.

## **22. Convert harm into benefit**

- a. *Utilize harmful factors or environmental effects to obtain a positive effect*
- b. *Remove a harmful factor by combining it with another harmful factor*
- c. *Increase the amount of harmful action until it ceases to be harmful*

*Example: When using high-frequency current to heat metal, it was found that only the outer layer became hot. This negative effect was later used for surface heat-treating.*

No ideas.

## **21. Rushing through**

*Perform harmful or hazardous operations at very high speed.*

*Example: A cutter for thin-walled plastic tubes prevents tube deformation during cutting by running at a very high speed (i.e., the cut is made before the tube has a chance to deform).*

No ideas.

## **Results**

The following ideas (shown in order of feasibility) resulted from considering the above Principles:

1. Make the ring from a composite material.
2. Use a multi-layer ring containing additional strengthening rings of different hardness and elasticity.
3. Use a ring that has a heterogeneous structure.
4. Additional protection from flying fragments if reliability is insufficient.
5. Use a disposable ring that will be destroyed while absorbing the energy of the fragments.
6. Apply a magnetic field to contain the fragments.

It is important to mention that most of these ideas are general in nature and require further specification.

## Working with the Improver System Software

### Develop concepts

The following menus were offered by the software:

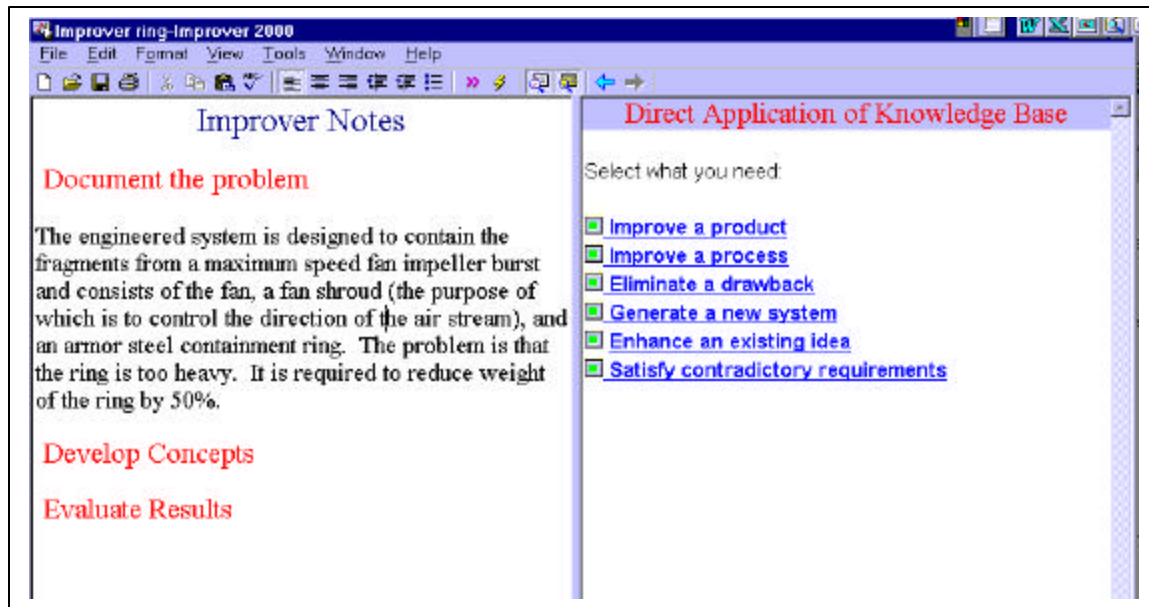

We selected *Improve a product*:

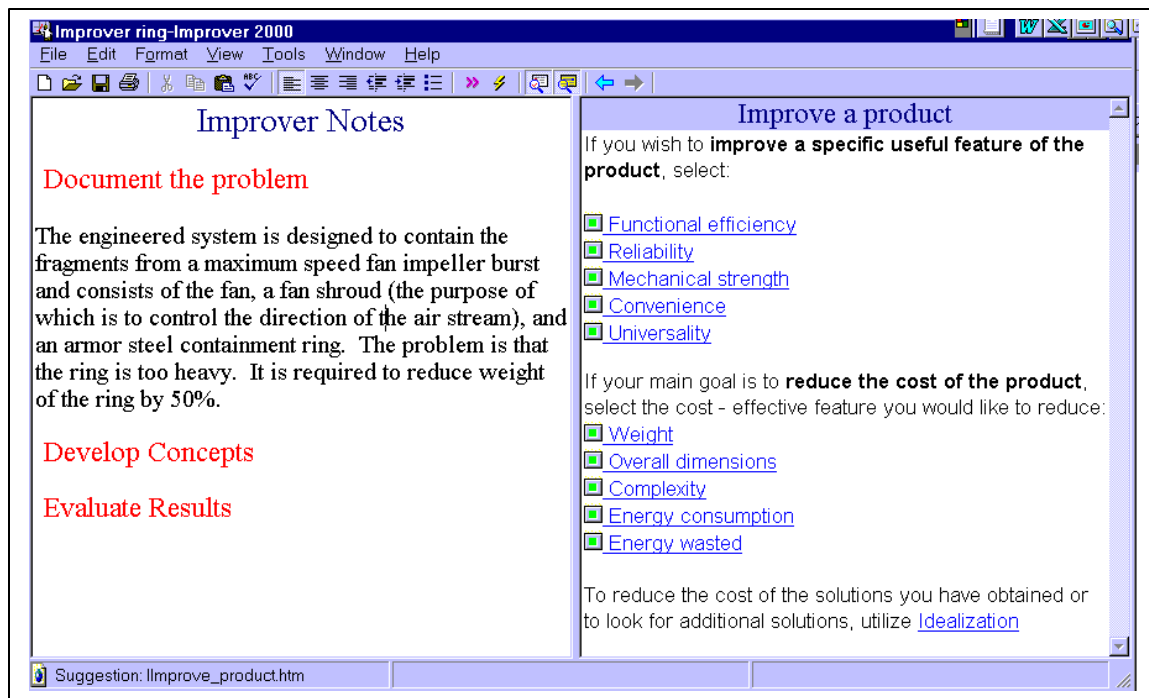

Our main problem is *Reduce weight*. The following Operators are recommended:

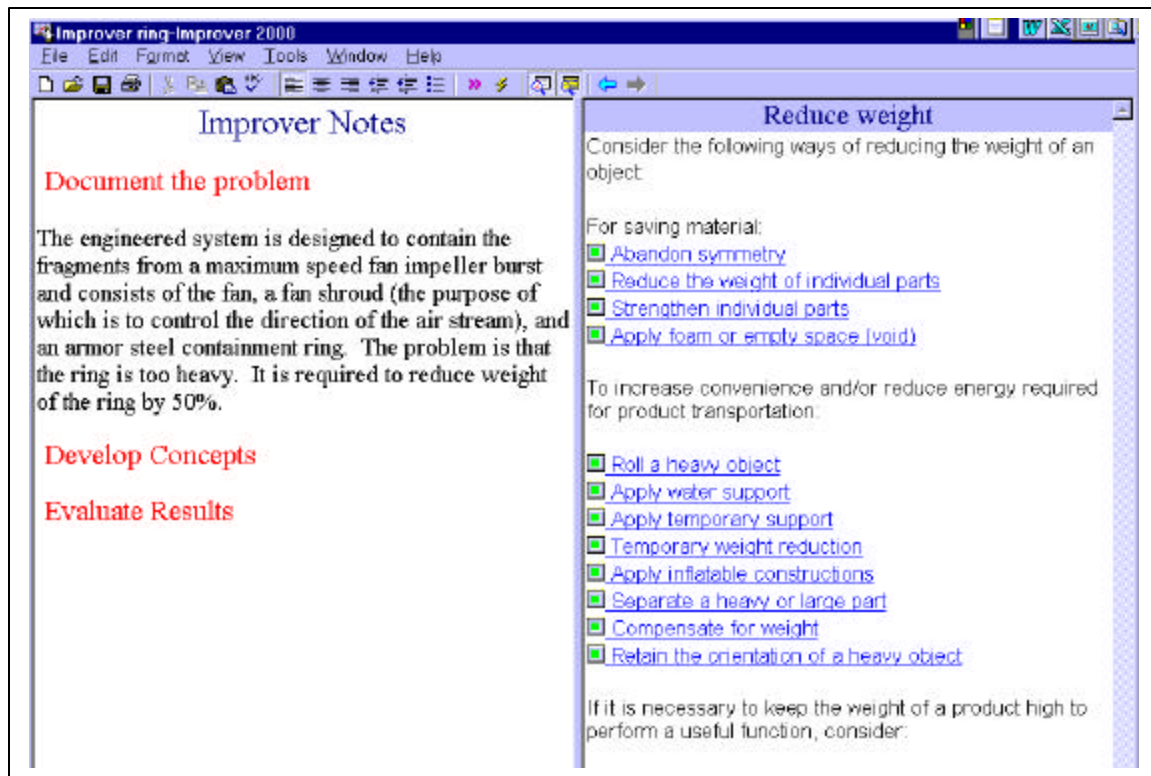

Additional typical problems and recommended Operators appear in the table below:

Typical problem	Recommended Operators
Improve mechanical strength	<ul style="list-style-type: none"> <li>• Transform an object's shape</li> <li>• Transform an object's structure</li> <li>• Introduce a strengthening element</li> <li>• Pre-load an object</li> </ul>
Improve reliability	<ul style="list-style-type: none"> <li>• Duplicate critical elements</li> <li>• Apply the module principle</li> <li>• Substitute for a set of simple objects</li> <li>• Continuous restoration of a damaged part</li> <li>• State stabilization</li> </ul>
Idealization	<ul style="list-style-type: none"> <li>• Exclude auxiliary functions</li> <li>• Exclude elements</li> <li>• Change the principle of operation</li> <li>• Use highly integrated components</li> <li>• Self-service</li> </ul>

Upon considering the recommended Operators (with their associated Illustrations) the following results were obtained:

**Operator: Abandon symmetry**

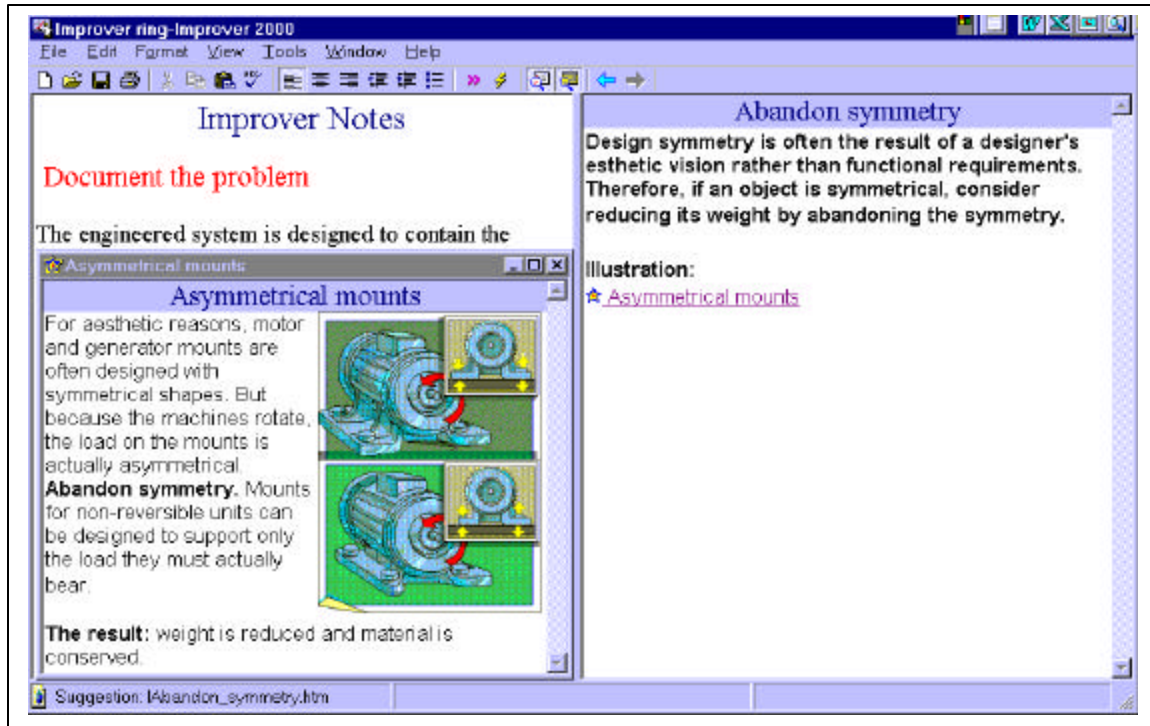

Idea #1: Vary the thickness of the ring tube, reducing the thickness where permissible.

**Operator: Reduce the weight of individual parts**

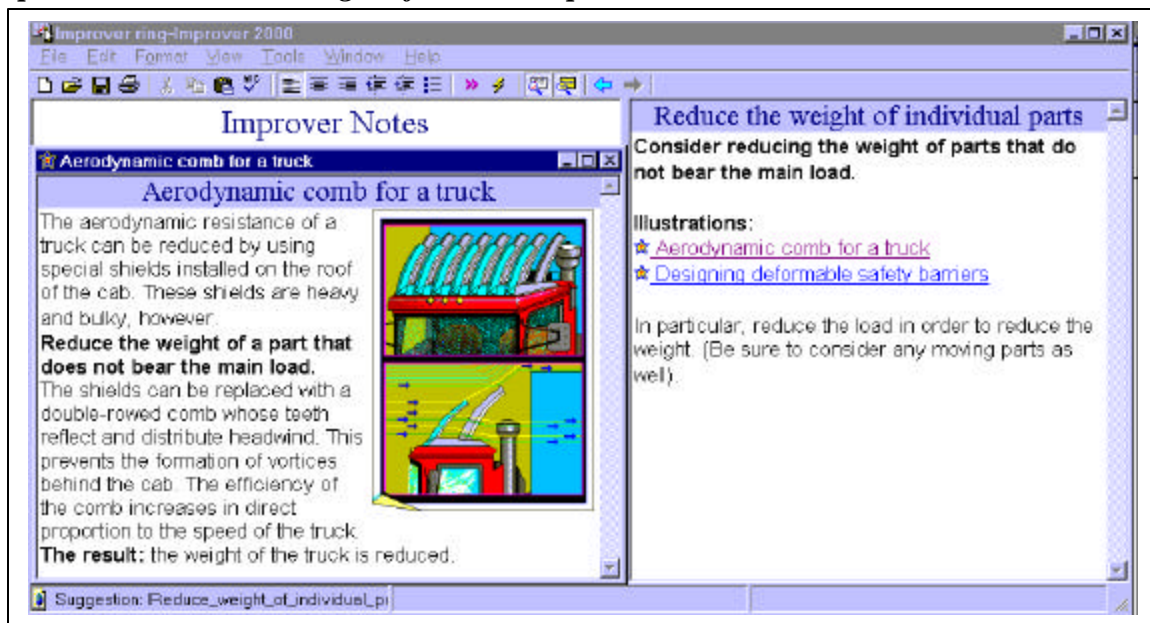

Idea #2: Reduce the energy of the fragments by reducing their weight (i.e., “help” the impeller break into smaller pieces). The ring is therefore not required to be as strong, and is lighter as a result.

In the interest of brevity, we will provide text extracted from the software rather than screen shots.

***Operator: Strengthen individual parts***

*Consider strengthening those parts that bear the main load and reducing the weight of parts that do not bear the main load.*

***Illustration: Containers for jettisoning loads***

*When an object is jettisoned from an aircraft, the container – as well as its contents – are susceptible to damage from the subsequent impact. Even if the container is rigid enough to withstand the impact, damage to the contents can result when they strikes the inner walls of the container.*

***Strengthen the part that bears the main load:*** *The outer layer of the container can be made of a light, rigid material that will be destroyed when it hits the ground, absorbing the energy of the impact. **Reduce the weight of the part that does not bear the main load:** The inner layer can be constructed of a flexible material, which resists puncture and breakage.*

***The result:*** *The weight of the container is reduced and the contents protected from damage.*

*This design reproduces an idea used with low-flying attack aircraft during World War II. Double armor was used in these aircraft: the outer layer was made of thin, breakable steel that absorbed or deflected the energy of a bullet; the inner layer was made of steel with a high plastic content which deformed, but was not punctured, upon impact.*

Idea #3: Use a multi-layer ring: additional strengthening rings, rings having different hardness and elasticity, rings which have a gap in between them where the gap is filled with an energy-absorbing material.

***Operator: Apply inflatable constructions***

*To make a product more effective or convenient or to reduce its weight, consider applying pneumatic (inflatable) constructions instead of mechanical ones.*

Idea #4: Replace the ring with an airbag inflated by the impeller burst.

***Operator: Transform an object's shape***

*Replace a mechanically weak element of an object with one having a special shape. Consider utilizing such shapes as:*

- *ribs or corrugated constructions, T-shapes, channels, box constructions*

Idea #5: Make a thin ring that has reinforcing ribs. If the ribs are placed on the internal surface of the ring, flying fragments will lose a large amount of their energy smashing into the ribs.

- *conformed to expected wear*

**Illustration: Sloped heels**

*The backs of shoe heels tend to wear down. In the past this was attributed to incorrect walking habits.*

*Shoes were designed with heels **shaped as if they were already worn down** – that is, which sloped up in the back. Jogging shoes and many other types of shoes and boots are now designed this way.*

**The result:** *the shoes are subjected to less wear.*

Idea #6: Determine the places where the ring is most likely to break, and reinforce these places.

- *opposite to a subsequently-occurring, undesired change*

**Illustration: Increasing spring strength**

*To increase the strength of a spring, the spring wire can be stretched before it is coiled.*

*Use an opposite shape. Another approach is to bend the spring wire before it is coiled. The bend must be in the opposite direction to the way the wire will bend when it is coiled.*

**The result:** *a preliminarily bent spring is stronger and more elastic.*

Idea #7: Introduce preliminary stress – for example, use additional rings which have been pressure-fitted to create a force directed toward the inside the ring.

**Operator: Transform an object's structure**

*Consider altering the structure or composition of an object in order to strengthen the most heavily-loaded or weakest part(s).*

*For this purpose, use:*

- *modifying portion of a substance*

**Illustration: Texturing iron sheets**

*To strengthen parts, in particular, space hardening to a rolled iron sheet, **by modifying this part**, a heated metal plate is rolled to produce a relief surface. The projections are then cooled and the plate is rolled with smooth rollers to flatten it.*

**The result:** *a flat plate can be produced which has a tempered (hardened) texture in certain regions.*

Idea #8: Use thermal treatment to harden the ring material.

- *substituting for a set of parts*

**Illustration:** *Using glass panes in a fighter*

*The original bulletproof glass windows used on fighter aircraft had a serious defect: When a bullet hit the window, a network of cracks formed and obstructed the pilot's vision.*

**Substitute a large piece with a set of smaller parts.** *The glass can be strengthened by forming the windows out of smaller panes of glass cemented to an acrylic plastic sheet. Transparent adhesive is used to join the edges of the glass panes.*

**The result:** *when a bullet hits the glass, only the affected pane cracks.*

Idea #9: Make the ring out of separate layers so that cracks that develop on the inside will not "spread."

- *introducing a strengthening additive*

**Illustration:** *Fibrous concrete*

*Ferro-concrete often develops fractures under tension. The fractures easily spread due to the dynamic effects of forces, vibrations, temperature changes, etc. Reinforcement with metal bars is ineffective because the bars are too sparsely distributed throughout the concrete.*

**Concrete can be reinforced by artificial fibers** *(steel, glass, basalt or synthetics) that are evenly distributed throughout the concrete as it is manufactured. Wires from used steel ropes are especially convenient for this purpose.*

**The result:** *Fibrous concrete used in airport runways has shown twice the service life of traditional ferro-concrete.*

Idea #10: Use special threads, such as are found in bullet protection vests.

Idea #11: Use ferro-concrete or some other composite material.

**Operator:** *Introduce a strengthening element*

To increase the mechanical strength of an object, try to use an object or material that supplies strength for the required time interval and can be easily removed afterwards.

**Illustration:** *Transporting window glass*

*While being transported, sheets of window glass are separated by paper, protected by chips, and packed in wooden cases. Even with these precautions, however, the glass often breaks.*

*Use material that supplies strength for the required time interval. Each sheet can be covered with a thin film of oil, and the sheets joined together to form a block. The glass can then be transported as a solid block, which is much stronger than the individual sheets.*

***The result:** tests show that when dropped from a height of two meters, the glass block sustains little damage. Conversely, more than 50 percent of the glass packed in the usual way breaks.*

See Idea #3 (multi-layer ring).

**Operator: Pre-load an object**

*Consider pre-loading an object in a way that will counter undesirable stress. When the object is stressed, the pre-loading must be overcome before undesirable stress develops. Inner stress can be created in advance.*

**Illustration: Manufacturing pre-stressed reinforcing rods**

*To make pre-stressed, reinforced concrete, reinforcing rods can be pre-loaded. For this purpose they are heated to 700 degrees C and clamped in place. Concrete is then poured around the rods. Only rods made of high-temperature steel can withstand the heat, but such rods are too costly for most construction applications.*

*For less expensive pre-stressed reinforcement, a steel bar can be connected to a reinforcing rod. The bar is then heated to 700 degrees C.*

***The result:** as it heats, the bar expands, stretching and pre-stressing the cold reinforcing rod.*

**Illustration: Strengthening a gun barrel**

*Pre-loading a gun prevents the barrel from rupturing when the gun is fired. Two ways to do this are as follows:*

*1 - a steel ring or pipe is pre-heated and placed around the barrel so that as it cools, it tightens and reinforces the barrel*

*2 - stretched wires or bands can be wound around the barrel.*

***The result is a reinforcing effect against pressure in the barrel.***

Idea #12: Create inner stresses inside the ring. This can be done, for example, using wiring, banding, a double-ring structure, etc.

**Operator: Duplicate critical elements**

*To increase an object's reliability, consider duplicating the most important or most unreliable subsystems or components.*

(Same as Idea #3.)

**Operator: Substitute for a set of simple (disposable) objects**

*Substitute an expensive or complex object with a set of inexpensive or simple objects, foregoing some desirable properties (e.g., longevity) as a result. If possible, make the object disposable.*

Idea #13: Use a disposable ring – i.e., a ring that will be destroyed while absorbing the energy of the fragments.

**Operator: Exclude auxiliary functions**

*Auxiliary functions provide support and contribute to the execution of the object's primary function(s).*

*In many situations an auxiliary function can be excluded (along with the elements and/or parts associated with the auxiliary function) without deteriorating the performance of the primary function(s).*

*Consider the following:*

- *Exclude correcting functions*
- *Exclude protective functions*
- *Exclude housing functions*

Consideration 1: The ring performs an auxiliary (i.e., corrective) function.

**Operator: Exclude correcting functions**

*Consider any function of your object whose sole purpose is to fix some inherent shortcoming (harmful action) of the object. Identify the shortcoming that is eliminated by each correcting function. Can the cause of the shortcoming be eliminated? If so, the object will no longer require this correcting function.*

*Sometimes an object can operate satisfactorily without eliminating the shortcoming. If so, the correcting function can also be eliminated.*

Consideration 1 (continued): The inherent shortcoming that the containment ring is designed to correct is an impeller burst. We should therefore consider a new problem: improving the mechanical strength of the fan to prevent it from bursting, and thus eliminating the need for a containment ring.

**Operator: Exclude elements**

*Consider excluding elements of an object by delegating their functions to resources.*

Consideration 2: We should also consider how other system elements might be used to perform the ring's function.

**Operator: Change the principle of operation**

*To simplify an object or process, consider changing the basic operating principle that is used.*

*In particular, replace a mechanical field for another, more easily-controlled field.*

Idea #14: Use a magnetic field to contain the fragments.

***Operator: Self-service***

*Make your system (object) serve itself, including support and repair operations.*

*For this purpose:*

*Step1: identify the service functions performed for your object by another object*

*Step2: consider object's elements to identify which of them can fulfill these functions*

Consideration 3: The fan should protect itself. We should consider the new problem formulated in Consideration 1.

## Evaluate results

The “Evaluate results” section of the Improver software offers the following options:

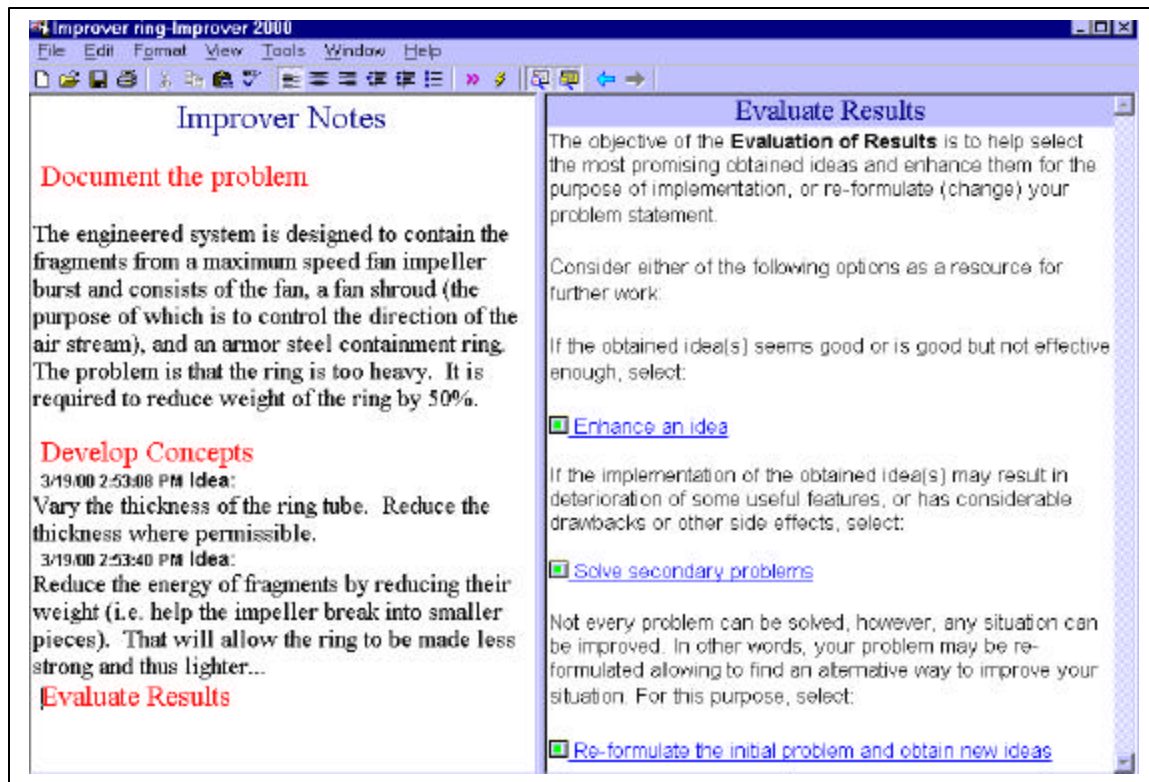

Working with the typical problems presented by the Improver yielded 13 ideas. These ideas were evaluated and prioritized, taking in consideration the following criteria:

- Performance
- Feasibility
- Novelty

The results are as follows:

Ideas #1 and 6: Vary the thickness of the ring, reducing the thickness where permissible. Determine the places where the ring is most likely to break, and reinforce these places.

Idea #2: Reduce the energy of the fragments by reducing their weight (i.e., “help” the impeller break into smaller pieces). The ring is therefore not required to be as strong, and is lighter as a result.

Ideas #3 and 9: Use a multi-layer ring: additional strengthening rings, rings having different hardness and elasticity, rings which have a gap in between them where the gap

is filled with an energy-absorbing material. Make the ring out of separate layers so that cracks that develop on the inside will not “spread.”

Idea #5: Make a thin ring that has reinforcing ribs. If the ribs are placed on the internal surface of the ring, flying fragments will lose a large amount of their energy smashing into the ribs.

Ideas #7 and 12: Introduce preliminary stress – for example, use additional rings which have been pressure-fitted to create a force directed toward the inside the ring. Create inner stresses inside the ring. This can be done, for example, using wiring, banding, a double-ring structure, etc.

Idea #8: Use thermal treatment to harden the ring material.

Ideas #10 and 11: Use special threads, such as are found in bullet protection vests. Use ferro-concrete or some other composite material.

Idea #4: Replace the ring with an airbag inflated by the impeller burst.

Idea #13: Use a disposable ring – i.e., a ring that will be destroyed while absorbing the energy of the fragments.

Idea #14 (which proposed the use of a magnetic field to contain the fragments) was excluded from the list due to the inability of a magnetic field to absorb the amount of energy we are dealing with in this system. Besides, fan can be made from a non-magnetic material.

## Enhance an Idea

We selected an idea that was considered highly feasible (Idea #2) for enhancement.

The options for enhancement are as follows:

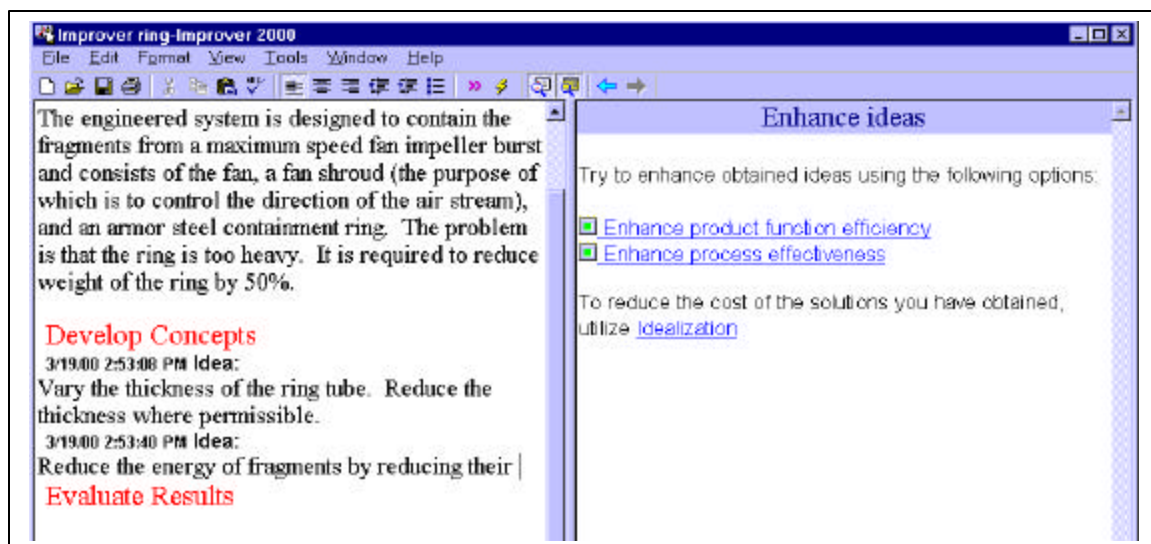

After selecting *Enhance product function efficiency*, the following recommendations were provided by the software:

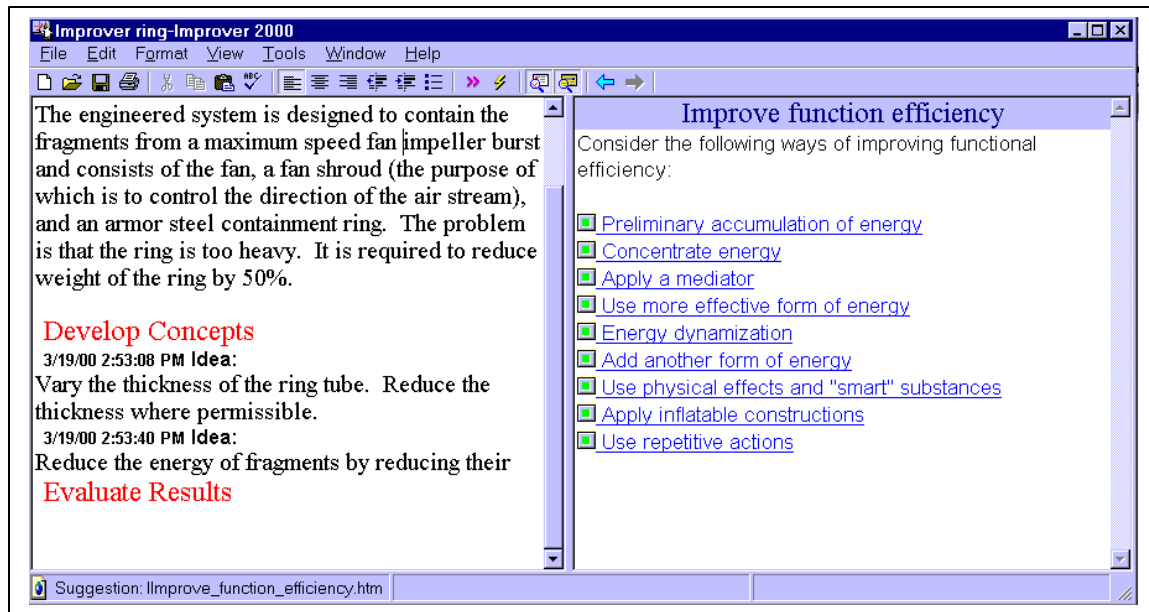

**Operator:** *Use a more effective form of energy*

*To enhance an object's function (or a process operation), consider replacing the energy that provides an existing function or operation with a more effective form of energy.*

**Illustration:** *Cutting steel pipes with a directed explosion*

*The methods conventionally used to cut steel pipes are labor-intensive, time-consuming, and inconvenient in extreme environments. (Some of these methods employ the use of gas or a single-point cutting tool.)*

*Use a more effective energy instead of the mechanical energy of cutting by using a directed explosion. To do this, a metal pipe filled with an explosive material curved into a ring is installed where the pipe is to be cut.*

***The result:** a simultaneous cut around the diameter of the pipe. Note: The cut can be specified at any angle with respect to the pipe's longitudinal axis.*

Idea #15: If the impeller breaks, a direct explosion should take place at the exact moment of the break. This would serve two purposes:

- Create a counteracting force that can keep the fragments in place
- Break the fragments into smaller pieces

## Solve secondary problems

The options for solving secondary problems are as follows:

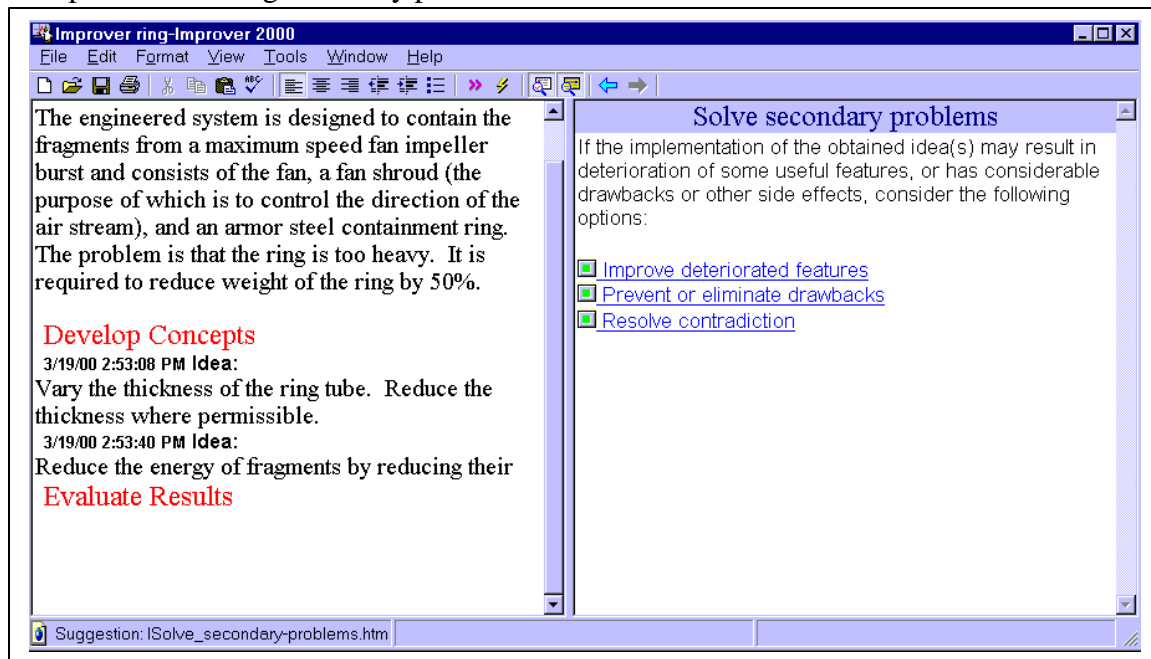

We select *Resolve contradiction*.

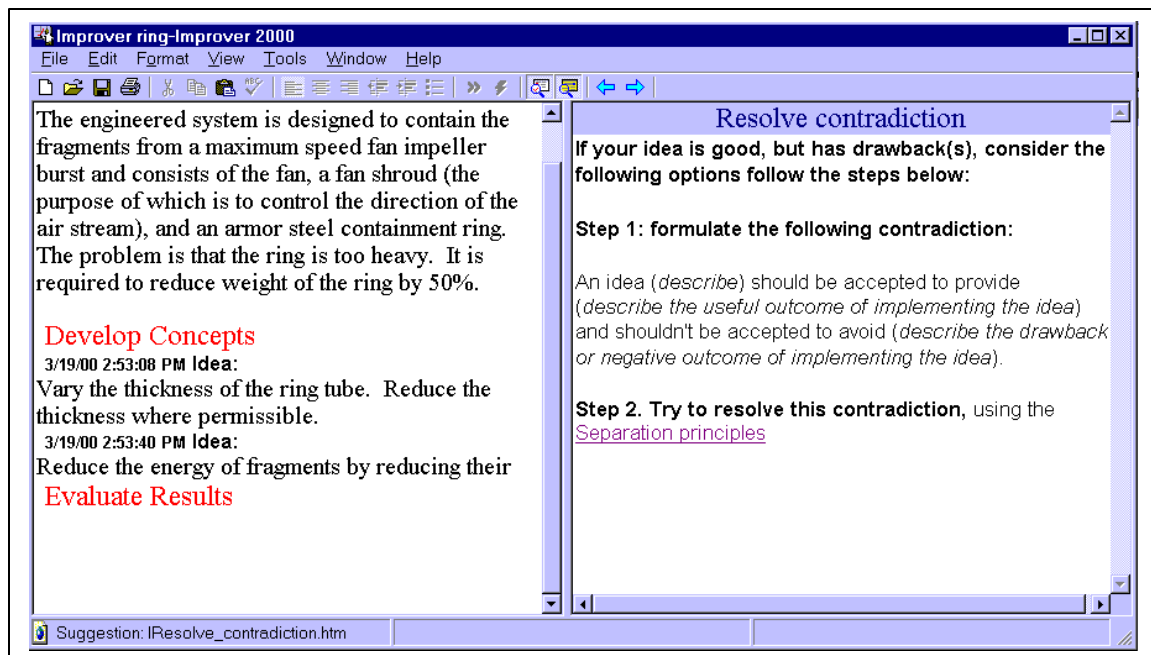

Idea #8 has a substantial drawback: hardening the ring can make it more brittle.

By using the “Resolve contradiction” template, we obtain the following contradiction:

An idea (harden the ring) should be accepted to provide (higher strength) and shouldn't be accepted to avoid (making the ring more brittle).

The following Separation Principles are considered:

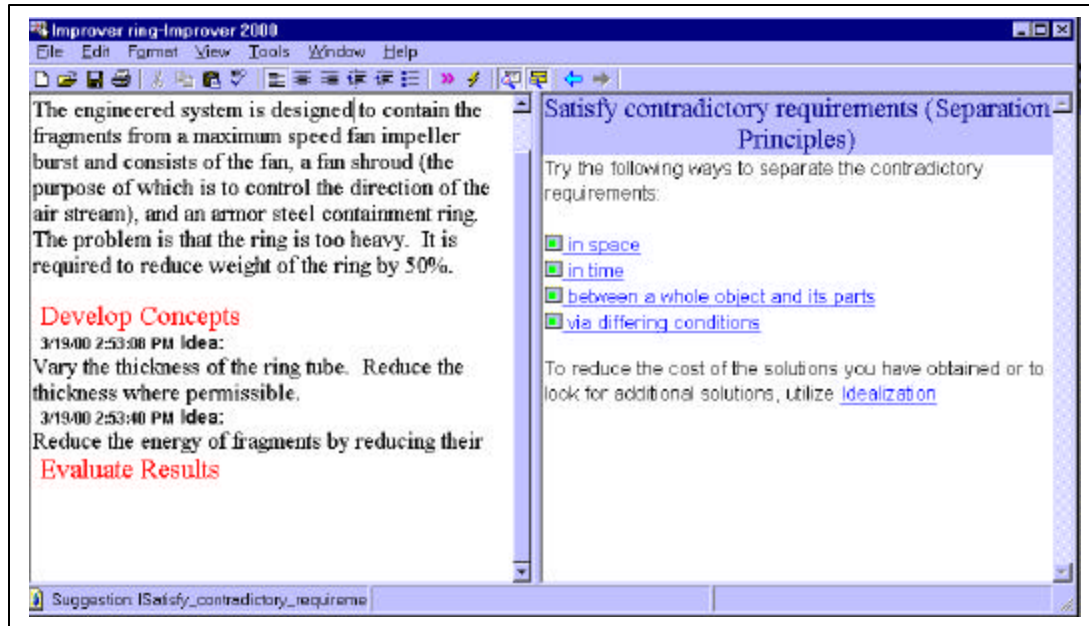

**Operator: Separating contradictory requirements in space**

*Try to separate contradictory (opposite) requirements in space. For this purpose:*

Step1: partition the object

Step2: assign each contradictory function or condition to a different part.

**Illustration: Method of coating**

*Metallic surfaces are chemically coated as follows: the metallic product is placed in a pool filled with a metal salt solution (e.g. nickel, cobalt, etc.). During the reduction reaction, metal from the solution precipitates onto the product surface. The higher the temperature, the faster the process; however, the solution decomposes at high temperatures, and up to 75% of the chemicals are wasted, settling on the bottom and walls of the pool. Adding stabilizers is not effective, and conducting the process at a low temperature sharply decreases production.*

*Apply separation in space. The solution should be hot where it is near the part, but cold elsewhere. The part is heated to a high temperature before it is immersed in the solution, and the process itself is conducted at a low temperature. One way of heating the part is by applying an electric current to it during the coating process.*

Idea #16: Introduce hardened segments uniformly distributed along the internal side of the ring made from a steel with higher plastic properties (see the Illustration entitled

“Containers for jettisoning loads” earlier in this case study). This idea is compatible with Ideas #3 and 9 (multi-layer ring design).

### Re-formulate the initial problem and obtain new ideas

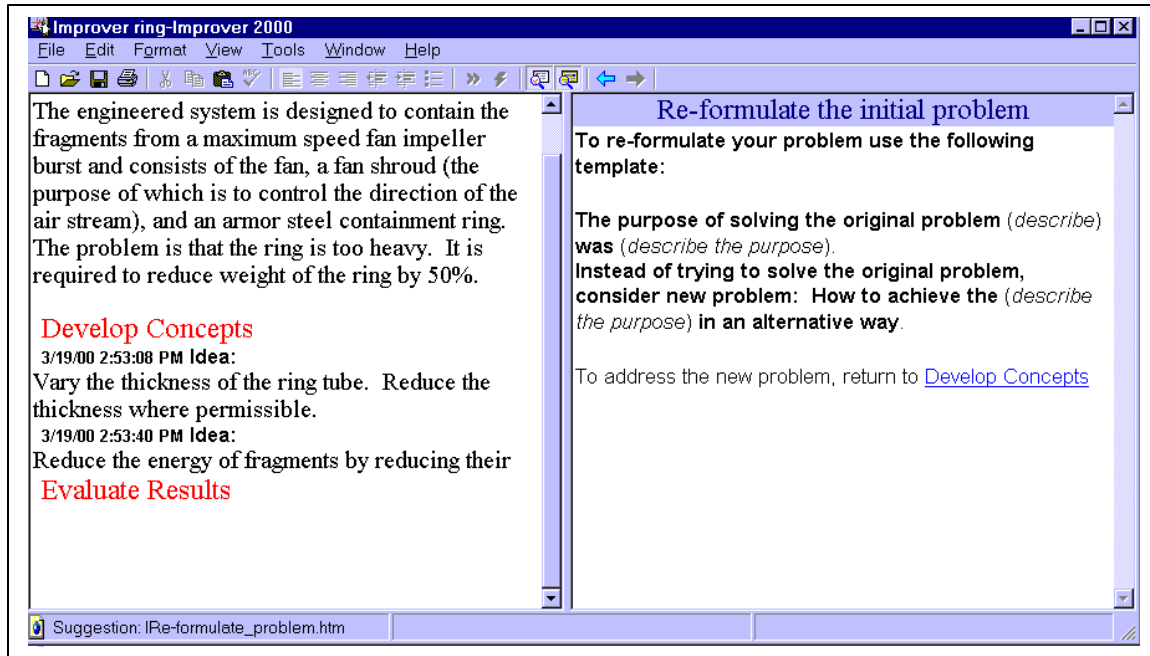

The purpose of improving the containment ring (reducing weight, increasing mechanical strength) is to enhance its corrective (i.e., protective) function of preventing fragments from flying away and causing severe damage. Thus, our new problem is: “Flying fragments.”

We return to the Improver’s main menu:

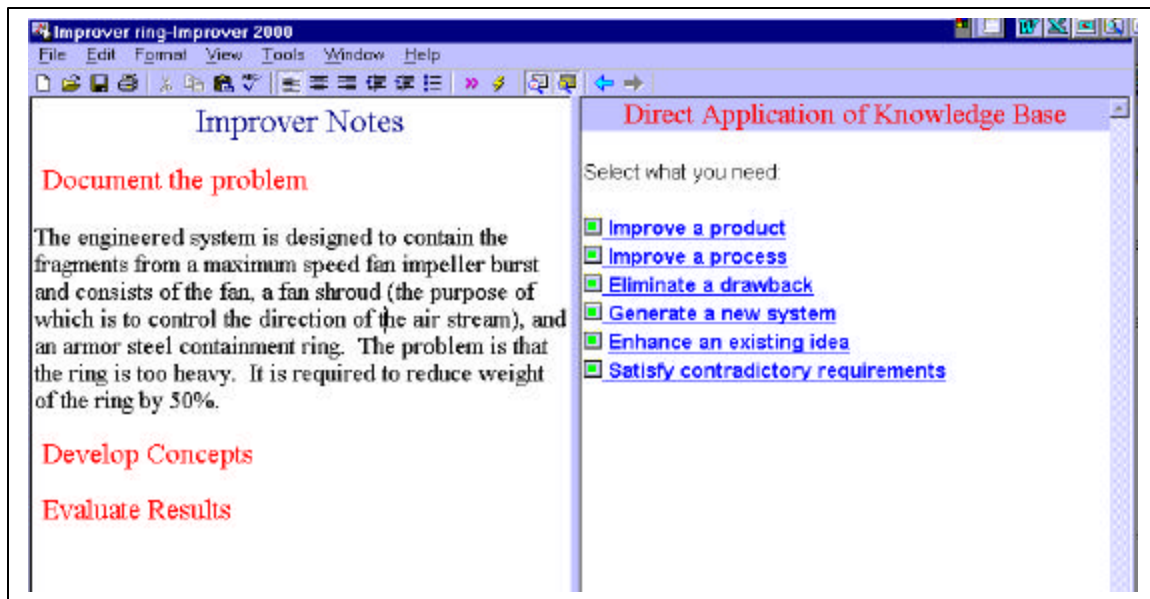

We select from a new group of Operators for the typical problem *Eliminate a drawback*:

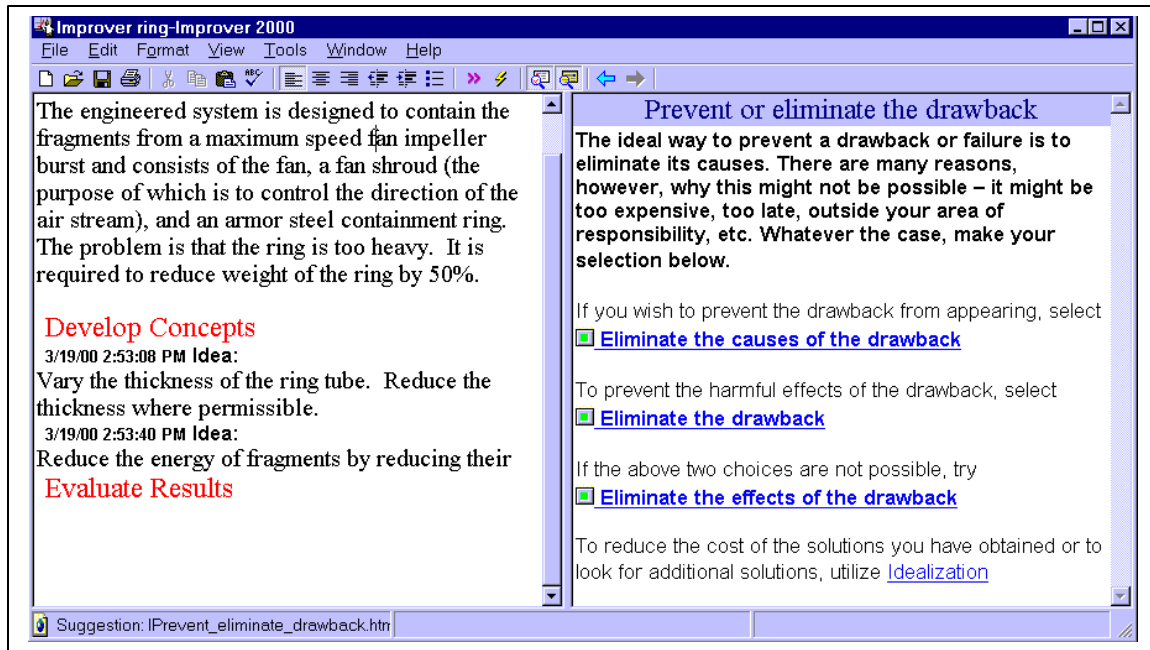

The cause of flying fragments is the impeller burst.  
The effect produced by flying fragments is the damage to the system.

The problem of preventing the impeller burst is already on our list of considerations. We can add to the list the problem: Reduce the damage caused by flying fragments.

Since for the purposes of this case study we are not targeting an exhaustive set of possible solutions, we will limit the analysis to eliminating the drawback itself – that is, to stop the fragments from flying. By selecting the item *Eliminate the drawback*, we obtain the following list of Operators:

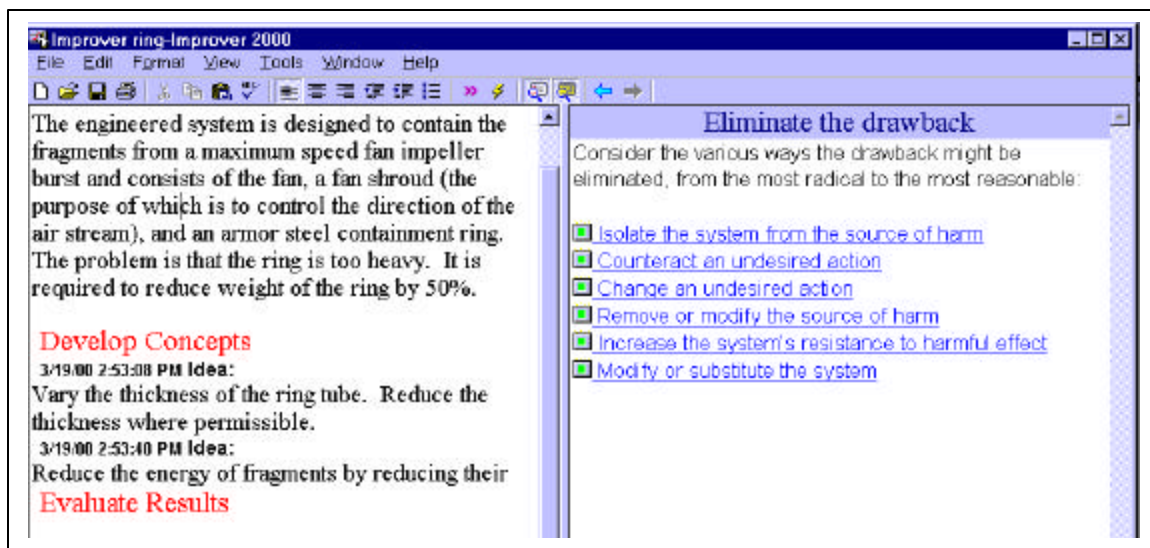

**Operator: Isolate the system from the source of harm**

*Consider isolating the system from the source of harmful effect.  
In particular, in case of fire or explosion.*

**Illustration: Using foam to contain blast fragments**

*When an old factory foundation was being demolished by explosion, there was a danger that blast fragments might damage nearby machine tools.*

**Isolate nearby objects from an explosion.** *The blast site was surrounded with a plywood form filled with foam.*

**As a result,** *the danger of damage due to blast fragments was completely eliminated.*

Idea #17: Use foam or foam-like material to absorb energy. For this purpose we would need a special type of foam such as metal foam. We can also consider using other fillings that absorb energy.

**Operator: Counteract an undesired action**

*Consider eliminating a harmful effect by using another effect. For this purpose, consider:*

- *combining with another harmful effect available in the system*
- *opposing an action that causes a harmful effect with another, similar action*
- *neutralizing the harmful effect with a countering effect*
- *opposing an action that causes a harmful effect with another, similar action*

**Illustration: Fighting fire with fire**

**Oppose a harmful action with a similar action.** *When a brushfire is raging, a backfire is set. When the brushfire and the backfire meet, the flames die out -- everything that can burn has already been consumed.*

**The result:** *brushfires can be controlled and extinguished.*

Idea #18: Consider the possibility of “firing back,” that is, explode the ring at the same instant the impeller bursts, so that the explosion shock wave counteracts the flying fragments. This idea is similar to Ideas #13 and 14.

**Operator: Change an undesired action**

*Consider changing the undesired effect in order to make conditions secure for the system. In particular:*

- *redirect the harmful action away from the system*
- *increase the intensity of a harmful action to the point where the effect is eliminated*

- *weaken the harmful effect by stretching out the time in which the action takes place*
- *if the harmful effect takes place at a point, consider changing the point contact to a line, surface, or volume contact*
- *redirect the harmful action away from the system*

Idea #19: Determine which directions are the least dangerous and try to redirect the flying fragments in one of these directions.

***Final list of concepts (listed in order of feasibility):***

1. Ideas #1 and 6: Vary the thickness of the ring tube, reducing the thickness where permissible. Determine the places where the ring is most likely to break, and reinforce these places.
2. Idea #2: Reduce the energy of the fragments by reducing their weight (i.e., “help” the impeller break into smaller pieces). The ring is therefore not required to be as strong, and is lighter as a result.
3. Ideas #3, 9 and 16. Use a multi-layer ring: additional strengthening rings, rings having different hardness and elasticity, rings which have a gap in between them where the gap is filled with an energy-absorbing material. Make the ring out of separate layers so that cracks that develop on the inside will not “spread.” Introduce hardened segments uniformly distributed along the internal side of the ring made from a steel with higher plastic properties.
4. Idea #5: Make a thin ring that has reinforcing ribs. If the ribs are placed on the internal surface of the ring, flying fragments will lose a large amount of their energy smashing into the ribs. In conjunction with Idea #2, sharp ribs can also break the fragments into smaller pieces.
5. Ideas #7 and 12: Introduce preliminary stress – for example, use additional rings which have been pressure-fitted to create a force directed toward the inside the ring. Create inner stresses inside the ring. This can be done, for example, using wiring, banding, a double-ring structure, etc.
6. Idea #8: Use thermal treatment to harden the ring material.
7. Ideas #10 and 11: Use special threads, such as are found in bullet protection vests. Use a composite material.
8. Idea #4: Replace the ring with an airbag inflated by the impeller burst.
9. Ideas #15 and 18: If the impeller breaks, a direct explosion should take place at the exact moment of the break. This would serve two purposes:

- Create a counteracting force that can keep the fragments in place
  - Break the fragments into smaller pieces
10. Idea #17: Use foam or foam-like material to absorb energy. For this purpose we would need a special type of foam such as metal foam. We can also consider using other fillings that absorb energy.
  11. Idea #13: Use a disposable ring – i.e., a ring that will be destroyed while absorbing the energy of the fragments.
  12. Idea #19: Determine which directions are the least dangerous and try to redirect the flying fragments in one of these directions.

## **Conclusion**

The advantages of utilizing the Improver software versus the Contradiction Table are as follows:

1. More recommendations (Operators) are offered for a given problem situation (44 for the Improver versus 11 for the Contradiction Table).
2. More ideas were obtained (19 versus 6).
3. More specific and refined recommendations allowed us to come up with more developed concepts.
4. The Improver software offered methods for enhancing a solution and guided us in reformulating the problem, which expanded the “solution space” relevant to the containment ring problem.

© 2000 Ideation International Inc.